

ZANUSSI

**Instructions
for the use and care
of EW800
washing machine**

Operating instructions

Contents

Installation

Unpacking	Page	3
Positioning-& levelling	Page	3
Water connection	Page	4
Electrical connection	Page	5

Operation

Controls description	Page	6
Loading the clothes	Page	7
Filling with washing powder	Page	7
Use of additives	Page	7
Which powder?	Page	8
Selection of washing programme	Page	8
Wash cycle	Page	9-10
Starting	Page	11
Stopping	Page	11

Care and cleaning

Cleaning the machine	Page	12
Cleaning the drain filter	Page	12
Care of washing powder dispenser	Page	13
Helpful tips for washing	Page	13

Servicing

Page 14

Technical data

Width

23.6 ins (600 mm)

Overall depth (excluding hose)

22.7 ins (550 mm)

Height

33.5 ins (850 mm)

Weight

178.5 lbs (80 kg)

Dry clothes capacity (excluding synthetic fabrics and wool)

10 lbs (4.5 Kg)

Revolutions during spinning

400/800 r.p.m.

Total power absorbed

2730 W

Heater rating

2300 W

Motor rating during washing

430 W

Motor rating during spinning

450/650 W

Water load: normal level

2.9 gals (13 l)

Water load: high level

4.4 gals (20 l)

Maximum water pressure

110 p.s.i.- 759 kN/m²

Minimum water pressure (cold)

7 p.s.i.- 48 kN/m²

Minimum water pressure (hot)

4 p.s.i.- 27 kN/m²

Supply voltage

220-240 V

Supply frequency

50 Hz

It is most important that this instruction book should be retained with the appliance for future reference. Should the appliance be sold or transferred to another owner, or should you move house and leave the appliance, always ensure that the book is supplied with the appliance in order that the new owner can be acquainted with the functioning of the appliance and the relevant warnings.

Warnings – Washing Machines

THESE WARNINGS ARE PROVIDED IN THE INTEREST OF SAFETY. YOU MUST READ THEM CAREFULLY BEFORE INSTALLING OR USING THE APPLIANCE.

- This appliance is designed to be operated by adults. Children should not be allowed to tamper with the controls or play with the product.
- It is dangerous to alter the specifications or attempt to modify this product in any way.
- Any electrical work required to install this appliance should be carried out by a qualified electrician.
- Any plumbing work required to install this appliance should be carried out by a qualified plumber.
- This product should be serviced by an authorised Zanussi Network Service Centre, and only genuine Zanussi spare parts should be used.
- Care must be taken to ensure that the appliance does not stand on the electrical supply cable.
- Always unplug the appliance and turn off the water after use.
- Do not overload the appliance. See relevant section in instruction book.
- Always look through the glass door to check if water has drained before opening the door. If water is present do not open door before draining the water. If in doubt, refer to the relevant instructions in this book.
- This appliance is heavy. Care should be taken when moving it.
- All packing and transit bolts must be removed before use. Serious damage can occur to the product and to property if this is not adhered to. See relevant section in instructions.
- The glass door becomes very hot during the washing cycle. Keep children away from the vicinity of the appliance whilst it is in operation.
- Leave the porthole door slightly ajar between washes to preserve the door seal.
- Do not overload the appliance. See relevant section in instruction book.
- Only wash fabrics which are designed to be machine washed. If in doubt, consult the manufacturer of that item.
- Before washing, ensure that all pockets are empty and buttons and zips are fastened. Avoid washing frayed or torn articles and treat stains such as paint, ink, rust, and grass before washing. Underwired bras must not be machine washed.
- Any objects such as coins, safety pins, nails, screws, stones or any other hard, sharp material can cause extensive damage and must not be placed into the appliance.
- Garments which are saturated with petroleum products should not be machine washed. If volatile cleaning fluids are used, care should be taken to ensure that the fluid is removed from the garment before placing in the machine.
- Wash small items such as socks, laces, washable belts etc in a washing bag or pillow case as it is possible for such items to slip down between the tub and the inner drum.
- Only use the advised quantities of fabric softener. Damage to the fabric can ensue if you over-fill. Refer to the manufacturers' recommendations of quantities.
- Pets have been known to climb into washing machines. Please check your drum before use.
- Under no circumstances should you attempt to repair the machine yourself. Repairs carried out by inexperienced persons may cause injury or more serious malfunctioning. Contact your local Zanussi Network Centre. Always insist on genuine Zanussi spare parts.

Installation

Unpacking

After removing the outer carton, reinforcing angles and polythene wrapping, proceed as follows:

1)
Unscrew and remove, by means of the special spanner that comes with the machine, the three big screws to be found on the back of the appliance (fig. 1).

The spanner supplied with the machine is provided with an hexagonal insert which can be used according to the type of screws which are at the back of the appliance.

2)
Insert a screwdriver into the free holes left after removing the bolts, and tilt it as required to cause the three plastic spacers inside the machine to fall down.

3)
Rest the washing machine on its back and remove the two inner angle packings by pulling the left string A first and then the right string B (Fig.2).

This operation should be carried out very carefully to prevent the angle packings from damaging the internal components of the machine.

4)
Remove the polystyrene base packing and the three plastic spacers that fell down during the preceding operations.

Note:

It is advisable to keep all parts, including the three bolts as per para 1) above, of the inner packing for re-use in case the machine has to be transported again.

Positioning & levelling

Set up the machine in its permanent operating position and then carefully level it, adjusting the two levelling feet (Fig.3) by means of the special small spanner that comes with the machine.

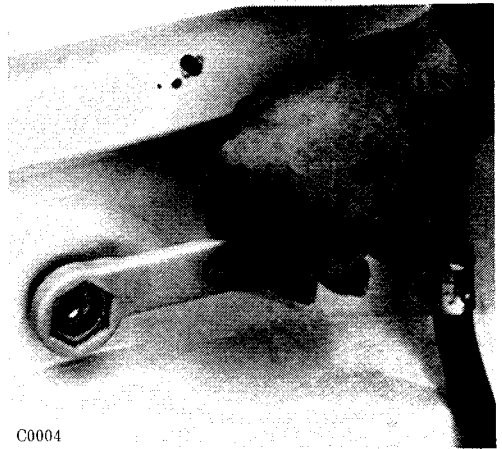

C0004

Fig. 1

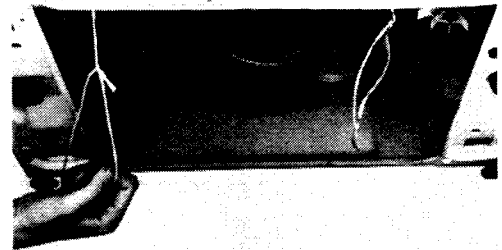

C0005

Fig. 2

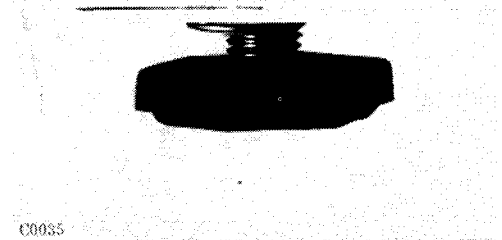

C0035

Fig. 3

We recommend that this work is carried out very carefully to avoid any vibration, noise or shifting of the appliance during operation.

Also make sure that the washing machine does not touch walls, furniture etc. whilst in operation.

Water connection

The machine may either be plumbed in or connected to existing taps. Details are given below.

Water supply

Separate supplies of hot and cold water are necessary.

Single outlet gas or electric heaters are not suitable.

If a cold water supply only is available, connect the two hoses to a cold water tap, using a 'Y' piece connector.

Water outlet connection

The drain pipe from this machine must connect into the main drain from the premises but not into the rainwater drain.

Information as to the type of drain servicing your premises can be obtained from a builder or the Local Authority. The curved end of the outlet hose should be firmly hooked over the edge of a sink or connected to a suitable drain pipe in the wall or under the sink; however, such a drain pipe should have a built-in air break in order to avoid water syphoning from the machine during draining. The top of the drain hose (curved end) should not be lower than 50 cms (20 ins) or higher than 85 cms (34 ins) from floor level (Fig.4).

The water should be able to drain freely and the end of the outlet hose must not be under water. It is, therefore, advisable that the drain pipe, if fused, has an internal diameter of at least 4 cms (1.5 ins).

Also, ensure that the drain hose is not choked or placed in such a way as to

obstruct the normal water flow. If the drain hose is to be hooked over the sink, ensure that the sink is empty and that the sink plug is not blocking the plug hole.

If an extension hose is required, it should not exceed a length of 180 cms. (6 ft.), its diameter should not be smaller than that of the original drain hose and the extension hose should not be choked (kinked) in any way.

The hose is to be positioned at floor level and only the terminal part should be placed at the requisite drain level previously indicated. A failure to comply with these requirements may result in a malfunction of the drain pump.

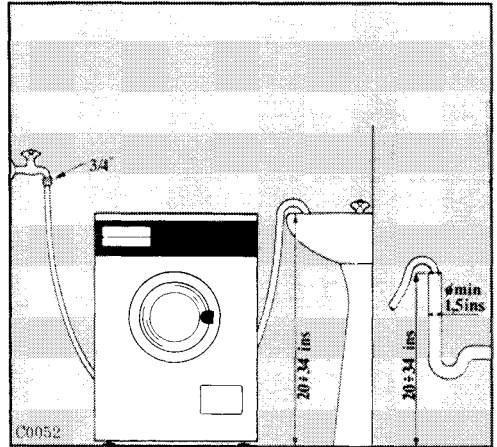

Fig. 4

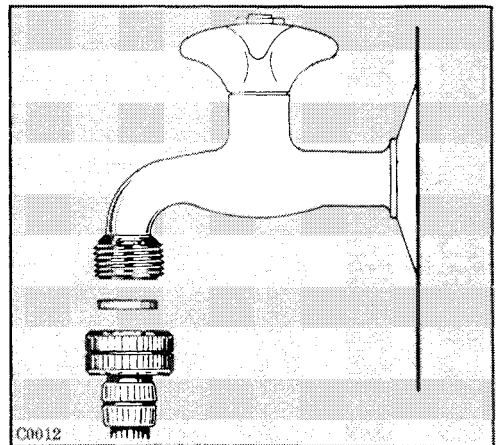

Fig. 5

To correctly carry out the extension of the drain hose, it is advisable to use the special connector with hose clamps which can be supplied as an optional attachment.

Plumbed installation

It is important that work is carried out by a qualified plumber.

Use from existing taps

- 1 - Mixer taps are unsuitable and must not be used.
- 2 - Connect the red pipe connection to the hot tap and the other to the cold tap (see note below).

Important

If the rate of flow on the cold water valve is too slow, remove the flow control device of the valve;

If the pressure on the hot tap exceeds approximately 10 lb. per square inch, it will be necessary to fit the flow control device, in the hot water valve.

Tap connections

For taps with a 3/4 inch gas thread, fit the washers into the inlet hoses and connect as shown (fig.5).

The other ends of the water inlet hoses, which are connected to the appliance, can be turned in any required direction by loosening their ring nuts.

After setting the inlet hoses as desired, be sure to tighten their ring nuts again to prevent leakages.

If the water supply is from new pipes or from pipes which have not been used for a long time, it is advisable to run off a certain amount of water before connecting the machine. This will avoid foreign matter blocking the filters.

Electrical connection

**WARNING:
THIS APPLIANCE
MUST BE EARTHED**

The manufacturer declines any liability should this safety measure not be observed.

If the plug that is fitted to your appliance is not suitable for your socket outlet, it must be cut off and the appropriate plug fitted.

The cut off plug should be disposed of to prevent the hazard of electric shocks in case it should be plugged into a 13 Amp socket in another part of your home.

Important

The wires in this mains lead are coloured in accordance with the following code:

**GREEN AND YELLOW - EARTH
BLUE - NEUTRAL
BROWN - LIVE**

If you fit your own plug, the colours of the wires in the mains lead of your appliance may not correspond with the markings identifying the terminals in your plug, this is what you have to do: Connect the green and yellow (earth) wire to the terminal in the plug which is marked with the letter «E» or the earth \perp symbol or coloured green, or green and yellow.

Connect the blue (neutral) wire to the terminal in the plug which is marked with the letter «N» or coloured black. Connect the brown (live) wire to the terminal which is marked with the letter «L» or coloured red.

The plug moulded on to the cord incorporates a fuse. For replacement, use a 13 Amp BS 1362 fuse. Only ASTA approved fuses should be used.

The fuse cover/carrier must be replaced in the event of changing fuse.

The right fuse cover/carrier colour is the one shown by the coloured insert at the base of the plug.

The plug must not be used if the fuse cover/ carrier is lost. A replacement cover/carrier must be obtained from Zanussi Service Agents whose addresses are listed on the attached «Zanussi Service Agents Nationwide».

This appliance complies with E.E.C. directive no. 76/889 of 4.11.76 relative to radio interference suppression.

Operating instructions

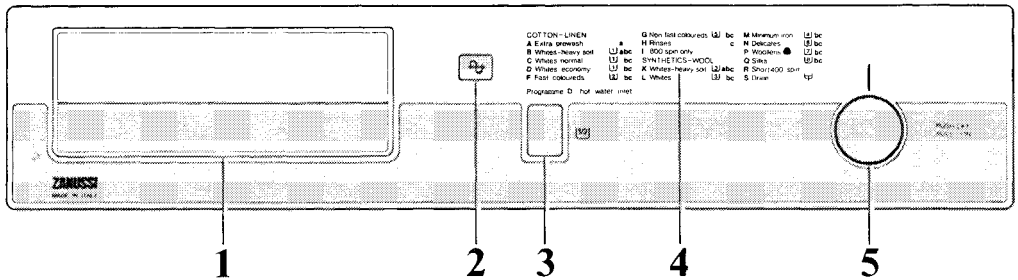

Controls description

Pilot lamp

When on, it shows that the appliance is operating.

When it goes out, it means that the wash cycle is completed.

Half-load pushbutton " $\frac{1}{2}$ ": when pressed in, this pushbutton will provide only half of the normal water load in the tub.

This makes it possible, when washing only a reduced load (not more than half of the normal dry load), to obtain a reduced water consumption and a considerable saving in electric power consumption. This pushbutton should not be pressed in when washing synthetics or woollens.

Programme selector

This permits selection of the required wash cycle by turning the knob clockwise until the letter corresponding to the desired programme coincides exactly with the pointer. Furthermore, by pulling it or pushing it, it lets you start or stop the machine.

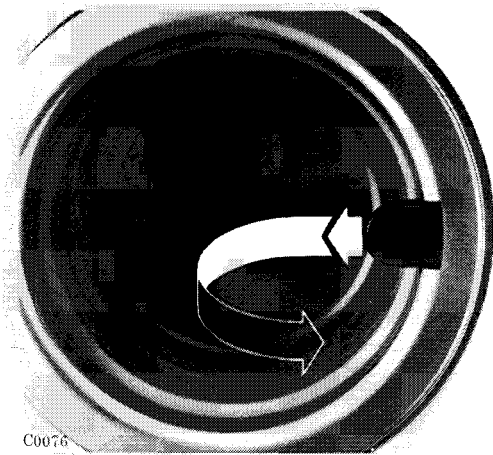

C0076

Fig. 6

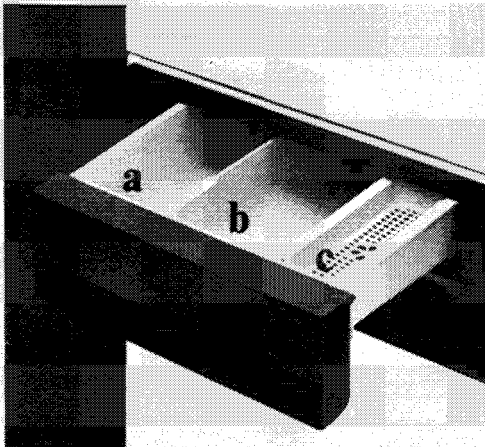

Fig. 7

Loading the clothes

It is always advisable to sort your laundry according to Fabric type and colour to obtain the best wash results. Open the door of the machine by pulling the small double-action catch (fig.6) to the left first and then outwards. Load the clothes spreading them out evenly and then close the door again.

Filling with washing powder

The washing powder dispenser is located on the front left of the control panel. It is very important to use a low lather powder (see paragraph "Which powder") such as Persil Automatic or Ariel Automatic.

Pull out the dispenser and add the washing powder. The amount of washing powder for the prewash should be put into section "a" (fig.7) of the dispenser and the powder for the main wash should be put into section "b". Once the dispenser is filled, close by pushing in.

Use of additives

The washing machine is designed to carry out special treatments such as the addition of fabric conditioners automatically at the end of some washing programmes. The conditioner liquids to be used should be put into compartment "c" (fig.7) of the dispenser at the beginning of the programme. These additives will be automatically used by the machine at the appropriate time. Take care to use the correct amount of additive, following the manufacturer's instructions; under no circumstances should the level of the liquid additive exceed the level of the grid in compartment "c" (fig.7). If this level is exceeded, the liquid additive is **wasted** because it flows directly into the wash tub.

Which powder?

Do **not use ordinary powders** in your new washing machine.

The reason for this is very simple, these powders produce so much lather that clothes are prevented from tumbling freely and are not properly cleaned. Do

use the right powder. To get the best results always use an automatic powder, we recommend **Persil Automatic**, or Ariel Automatic.

Like all modern automatic machines the EW800 works at peak efficiency with a low lather product.

These products' balanced lather is specially designed to complement the cleaning action of these machines.

So use it regularly for trouble free washing and superb results.

Selection of washing programme

The washing machine carries out 11 washing programmes and 4 additional programmes. Each programme has been specially designed for a specific type of fabric (e.g. cotton, synthetic fibres, wool etc.) and incorporates the H.L.C.C. care labelling scheme.

The appropriate programme must therefore be chosen according to the type of fabric to be washed.

SMALL LOAD OR LIGHT SOILING	FULL LOAD OR HEAVY SOILING
SOFT WATER 1 CUP	SOFT WATER 1 - 2 CUPS
HARD WATER 1 - 2 CUPS	HARD WATER 2 - 2.5 CUPS

Do **use enough powder.** To get your clothes really clean it is essential that enough powder is used in the machine. The correct amount will depend on a number of things: the hardness of water, the size of the load, and the amount of soiling present.





As a guide we suggest you follow the table above and adjust the amounts in light of your personal experiences.

You may find it helps to use a measuring cup at first.

Energetic wash cycle

For Cotton, Linen and Hemp Fabrics

Recommended wash load: 10 lbs (4.5 Kgs) max.

Wash cycle	Position of programme selector	Dispenser compartments to be used for			Wash cycle description
		washing powder	fabric conditioner, if any		
Extra prewash	A	a			Prewash in water at 40 °C (normal level) followed by a soaking phase (the laundry is left soaking in water). To drain the water, turn the programme knob to cycle «R» (drain with a gentle spin) or «S» (drain).
Whites-heavy soil	 B	a-b	c		Prewash in water at 40 °C (normal level). Main wash in water at 90 °C (normal level). 4 cold water rinses (high level). Spinning.
Whites	 C	b	c		Main wash in water at 90 °C (normal level). 4 cold water rinses (high level). Spinning.
Whites * economy	 D	b	c		Intake of hot water. Main wash in water at 90 °C (normal level). 4 cold water rinses (high level). Spinning.
Fast coloureds	 F	b	c		Main wash in water at 60 °C (normal level). 4 cold water rinses (high level). Spinning.
Non-fast coloureds	 G	b	c		Main wash in water at 40 °C (normal level). 4 cold water rinses (high level). Spinning.
Rinses	H		c		4 cold water rinses (high level). Spinning.
800 spin only	I				Spinning for about 6 minutes with simultaneous water draining. This is preceded by slow rotations of the drum.







*This economic wash cycle is only for machines with hot water connection.

Gentle wash cycles

For Delicates, Synthetics, Mixed Fabrics and Woollens

Recommended wash load: max. 3-5 lbs (1.5-2 Kgs); wool max. 2 lbs (1 Kg).

Important: There is no water draining in the last rinse of the gentle wash cycles, to prevent the clothes from creasing they are left in the machine at the end of the wash cycle. To drain the water, turn the programme selector knob to cycle «**R**» (draining & gentle spinning) or cycle «**S**» (draining without spinning).

Wash cycle	Position of Wash cycle selector	Dispenser compartments to be used for washing powder	fabric conditioner, if any	Wash cycle description
Whites heavy soil	 K	a-b	c	Prewash in water at 40 °C (normal level). Main wash in water at 60 °C (high level). 3 cold water rinses (high level).
Whites	 L	b	c	Main wash in water at 60 °C (high level). 3 cold water rinses (high level).
Minimum iron	 M	b	c	Main wash in water at 50 °C (high level). 3 cold water rinses (high level).
Delicates	 N	b	c	Main wash in water at 40 °C (high level). 3 cold in water rinses (high level).
Woollens 	 P	b	c	Main wash in water at 40 °C (high level). 3 cold water rinses (high level).
Silks	 Q	b	c	Main wash in water at 30 °C (high level). 3 cold water rinses (high level).
Short 400 spin	R			Water draining followed by a short spin.
Drain	S			Water draining with a steady drum.

Starting

After loading the clothes, the washing powder and the fabric conditioners into the respective compartments, make sure - before you start the machine - that:

the plug is in the wall socket

the water tap is turned on (fully open)

the drain hose is correctly placed

the loading door is correctly closed.

You may now select the required wash cycle by turning the programme control knob clockwise after making sure that it is pressed in.

It is very important that the timer knob is exactly pointed on the dial, especially when selecting spinning.

Press in the required pushbutton, if any.

At this point, to start the washing machine simply pull the programme control knob (and the pilot lamp lights up).

Once it is started, the machine will automatically carry out all phases of the selected programme.

Stopping

When the programme is completed (pilot lamp goes out), the machine stops automatically.

You should now press in the programme control knob. Wait for about 1-2 minutes after the wash cycle is completed before opening the door, to allow the door safety device (interlock) to release it.

Open the door only after the wash cycle is completed. In the case of the "gentle" wash cycles, don't forget to drain the water prior to opening the door.

If need be, you may stop the machine at any given moment during the cycle by pushing in the programme control knob.

If the machine stops during a spinning phase, it is absolutely necessary — to restart it — that you reset the machine on the programme immediately preceding the stopping point.

When the wash cycle is completed, it is advisable to unplug the machine from the wall socket and to turn off the water tap(s).

Care and cleaning

Cleaning the machine

Important: Make sure that the plug has been removed from the socket prior to undertaking any kind of maintenance. From time to time, carry out a complete cycle without a washing load, adding 25g (1oz) of "Calgon". This should also be done when the machine has been out of use for a long time.

Leave the door ajar for about 2 hours after the wash to allow air to circulate freely inside the machine.

Plated, polished and plastic parts and the glass door should be cleaned with a soft damp cloth, never with an abrasive cleaning powder.

For the cabinet exterior use a lukewarm solution of mild soap, then rinse and dry carefully. It is also advisable to clean the cabinet, from time to time, with a wax polish applied with a soft cloth.

Cleaning the drain filter

This machine incorporates a mechanical filter (located in the front side of the cabinet) the purpose of which is to collect lint and any small object inadvertently left in the articles to be washed.

If this filter is allowed to clog, it could make water draining difficult.

It should therefore be cleaned regularly as follows:

Detach the drain hose from its hanger on the back of the appliance and place the free end of the hose at floor level into a basin to collect any excess water.

Open the small flap door (Fig.8).

Then, using the special spanner that comes with the machine, unscrew and remove the filter (Fig.9-10).

Clean the filter thoroughly and then replace it, making sure that it is screwed down firmly into its housing.

When replacing the filter, be sure to fit it exactly into its special guide.

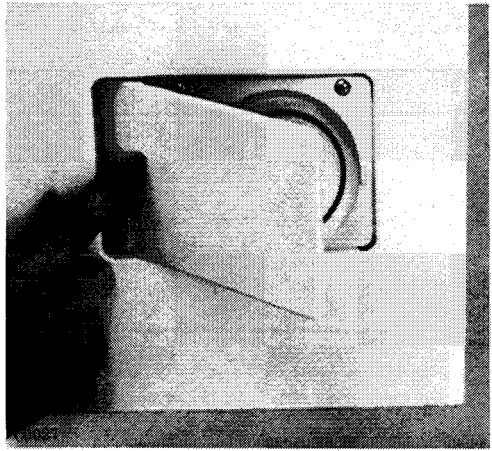
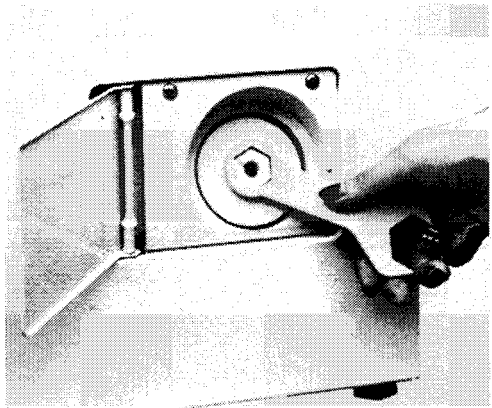

Fig. 8



C0028

Fig. 9

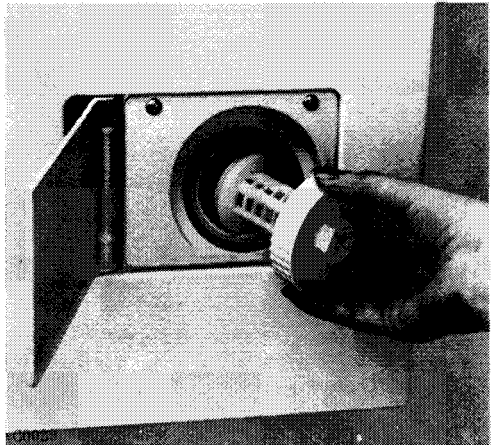

Fig. 10

Care of washing powder dispenser

We recommend that the washing powder dispenser is checked regularly to ensure that it is clean and dry. Do wipe it after each wash.

Should the dispenser require special cleaning, the drawer can be completely removed, and the interior cleared of any deposit.

The drawer can be removed from the front of the appliance by giving a sharp pull outwards.

A sharp tap with the palm of the hand may be necessary when replacing the drawer.

Helpful tips for washing

Here are some practical hints to enable you to obtain the best washing results:

Use a low lather washing powder specially made for front loading washing machines.

An excessive amount of suds will cause unsatisfactory operation.

The quantity of washing powder required depends on the amount of laundry and on how soiled it is. It may therefore be necessary to vary the quantities suggested in this book according to experience.

In order to get good results when washing synthetic materials use a maximum washing load of 4 to 5 lbs.

The cycle P is a special cycle for washing wool garments bearing the woolmark label "Pure New Wool washing shrink resistant".

To obtain the best results when washing wool do not wash more than 2 lbs. at a time.

If your water is hard it can be softened by adding special products such as "Calgon" to the washing powder in the compartment B (fig.8).

These products facilitate the action of the washing powder and help to give better results.

Clothes should be sorted according to fabric type, degree of soil and colour fastness.

Tears and open seams should be mended, loose buttons secured, zippers closed and laces or belts collected in a cotton bag. Ensure that pockets are emptied, and spots of rust, paint, ink etc., are removed before washing.

Always turn off the water taps fully when the machine is not in use, even if it is plumbed in.

If, after commencing a wash, you find the wrong programme has been selected, push the control knob fully in turning the indicator knob clockwise to the correct programme. Then pull control knob fully out again.

Washing powder should only be placed in the dispenser immediately prior to the start of a programme. Do not leave washing powder in the dispenser for any length of time as it may form lumps which can be difficult to dissolve.

It is advisable to inspect the filters in the water inlet hoses periodically and clean if necessary.

Servicing

Should servicing be required for this appliance contact your local Zanussi Service Agent but before requesting service the following simple checks may save you inconvenience and expenses:

The machine won't start

Check that:
the plug is firmly in the wall socket and that there is an electricity supply by plugging in another appliance;
the door of the machine is firmly closed;
the programme control knob is actually pulled out;
the required programme is correctly selected;
make sure the fuses of your electrical installation have not blown.

The machine won't fill

Check that:
the water tap is actually turned on and that there is sufficient pressure;
the fill hose is not sharply bent.

The machine won't drain or spin

Check that:
the drain hose is not sharply bent (kinked) or placed in such a way as to obstruct a normal water flow;
the drain filter is not clogged.

The machine fills, but the water empties from the drain hose

Check that:
the end of the drain hose is not placed too low from floor level.

The machine vibrates or is too noisy

Check that:
the inner packing (transit security) was correctly removed, as described in paragraph "Unpacking";
the machine is correctly levelled as described in the relevant paragraph;
the machine is not too close to a wall or to the furniture.



ZANUSSI STANDARD GUARANTEE CONDITIONS

This guarantee is in addition to your statutory and other legal rights which will not be excluded or in any way diminished by the return of the guarantee card.

We, Zanussi Limited, undertake that if, within twelve months (24 months for TV sets) of the date of the purchase, this ZANUSSI appliance or any part thereof is proved to be defective by reason only of faulty workmanship or materials, we will, at our option, repair or replace the same **FREE OF ANY CHARGE** for labour, materials or carriage on condition that:

—The appliance has been correctly installed and used only on the electricity supply stated on the rating plate.

—The appliance has been used for normal domestic purposes only, and in accordance with the manufacturer's operating and maintenance instructions.

—The appliance has not been serviced, maintained, repaired, taken apart or tampered with by any person not authorised by us.

—The appliance is still in the possession of the original purchaser.

All service work under this guarantee must be undertaken by a Zanussi Network Service Centre (or the Zanussi Authorised TV Service Dealer).

Any appliance or defective part replaced shall become our property.

Exclusions

This guarantee does not cover:

—Damage or calls resulting from transportation, improper use or neglect, the replacement of any light bulbs or removable parts of glass or plastic.

—Costs incurred for calls to put right machines improperly installed or calls to machines outside the UK and the Republic of Ireland.

—Appliances found to be in use within a commercial environment, plus those which are the subject of rental agreements.

—Television receivers - routine adjustment, or poor reception resulting from a source outside of the receiver.



ZANUSSI 5 YEAR COVER CONDITIONS

For a once-only payment you can extend your Standard Guarantee to 5 years. All the conditions and exclusions of the Standard Guarantee apply.

Notes

1. Products supplied as "seconds", refurbished, damaged or shop-soiled are not eligible for Zanussi 5 year cover.

2. The issue of a cover does NOT by virtue of our having done so, nullify the exclusions.

3. The Engineer will need to check the details of your Cover card and may make a charge for his services if it is not presented to him at the time of his call.

4. The date of purchase, or the date of initial payment (deposit) of the appliance will be deemed the date of commencement of cover.

5. Covers issued are not refundable or transferable.

ZANUSSI
The appliance of science